



In-line centrifugal duct fans suitable for wide range of general residential, commercial and industrial exhaust or supply ventilation applications.

#### Description

Circular in-line duct fans from 100 to 400 mm diameter.

Models are suitable for mounting in any orientation and operation within ambient air temperatures between -20°C up to +40°C. Comprehensive range of accessories to ease the installation and control the fan performances.

#### Construction

Fan casing manufactured from high-grade corrosion-resistant pressed galvanised steel, with black polyester paint coating.

Fully airtight sealed assembly.

Direct drive centrifugal impeller.

Brushless EC motor, IP44, with thermal overload protection, suitable for single phase supply 230V +/- 15%/50-60Hz.

Fan speed adjustable with the potentiometer placed in the connection box or with an external control type REB-ECOWATT.

Analogue input with terminals in the terminal box to control the fan with 0-10V input signal.



#### Mounting foot

Supplied with unit as standard (Models 100 to 315).



#### Models 355 and 400.

### TECHNICAL CHARACTERISTICS

Before installation check that the product electrical characteristics listed on the data plate label (voltage, power, frequency, etc.) match those of the intended electrical supply.

Model	Signal voltage (V)	Speed (rpm)	Maximum absorbed power (W)	Maximum absorbed current (A)	Maximum airflow (m <sup>3</sup> /h)	Sound pressure level LpA @ at 3m* (dB(A))			Weight (kg)	Wiring diagram** (nº)
						Inlet	Radiated	Outlet		
VENT-100 ECOWATT	10	2810	61	0,40	300	50	41	48	4,0	49
	8	2325	41	0,30	250	47	38	43		
	6	1790	22	0,20	200	38	34	38		
	4	1310	12	0,10	150	31	29	31		
VENT-125 ECOWATT	10	2800	65	0,50	380	50	41	48	4,0	49
	8	2330	46	0,30	330	46	38	44		
	6	1780	24	0,20	250	40	35	38		
	4	1275	12	0,10	180	32	29	31		
VENT-150 ECOWATT	10	2910	115	0,80	660	57	38	55	5,0	49
	8	1550	80	0,60	580	54	38	52		
	6	1910	36	0,30	420	47	34	44		
	4	1360	16	0,10	300	37	24	35		
VENT-160 ECOWATT	10	2860	109	0,80	710	56	37	55	5,0	49
	8	2430	70	0,50	590	53	40	52		
	6	1860	34	0,30	450	46	33	44		
	4	1330	16	0,10	320	37	28	36		
VENT-200 ECOWATT	10	2580	136	0,90	920	54	35	54	5,0	49
	8	2260	92	0,70	800	49	32	50		
	6	1750	46	0,30	630	43	28	44		
	4	1300	22	0,20	450	36	24	36		
VENT-250 ECOWATT	10	2580	137	0,90	1030	56	39	57	6,0	49
	8	2210	87	0,60	880	52	35	54		
	6	1740	45	0,30	700	45	29	49		
	4	1280	22	0,20	520	39	24	49		
VENT-315 ECOWATT	10	2570	285	1,80	1650	61	46	63	8,0	49
	8	2210	185	1,20	1440	57	44	59		
	6	1720	93	0,60	110	51	45	53		
	4	1260	41	0,30	790	44	38	53		
VENT-355 ECOWATT	10	1410	248	1,00	2620	53	43	55	17,0	49
	8	1260	178	0,80	2310	50	39	52		
	6	1060	109	0,50	1940	47	36	48		
	4	860	63	0,30	1590	43	32	43		
VENT-400 ECOWATT	10	1400	376	1,60	3390	55	44	58	22,0	49
	8	1240	266	1,10	3000	52	42	54		
	6	1050	162	0,70	2530	47	37	49		
	4	870	96	0,40	2070	41	33	43		

\* Sound pressure level measured in free field condition at 3m, at the medium working point on the performance curve, shown 2, 5, 8 and 11.

\*\* See section of Wiring Diagrams.

**DIMENSIONS (mm)**

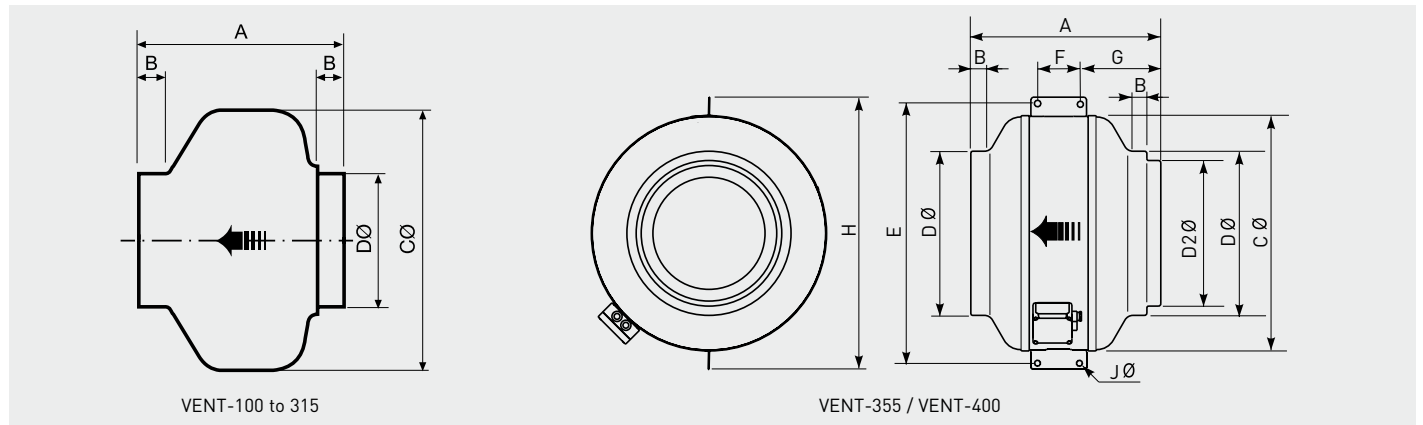

Model	A	B	C	D	D2	E	F	G	H	J
VENT-100 ECOWATT	251	23	243	98						
VENT-125 ECOWATT	253	27	243	123						
VENT-150 ECOWATT	214	24	333	147						
VENT-160 ECOWATT	222	28	333	157						
VENT-200 ECOWATT	223	25	333	198						
VENT-250 ECOWATT	206	27	333	248						
VENT-315 ECOWATT	230	25	401	312						
VENT-355 ECOWATT	410	25	508	354	314	410	100	170	587	11
VENT-400 ECOWATT	441	25	568	399	354	441	100	185	647	11

**PERFORMANCE CURVES - ACOUSTIC CHARACTERISTICS**

- $q_v$ : Airflow in  $m^3/h$ .
- $p_{sf}$ : Static pressure in Pa.
- P: Input power in W.
- SFP: Specific fan power in  $W/m^3/s$  (blue curves).
- Performance data in accordance with ISO 5801:1997.

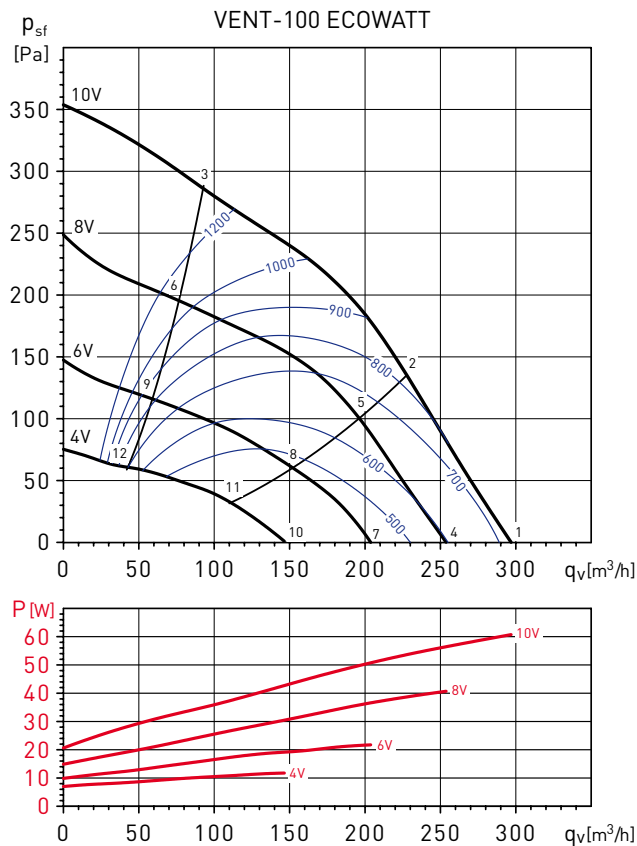

Working point		63	125	250	500	1000	2000	4000	8000	LwA
1	INLET	42	53	62	65	68	63	53	44	71
	OUTLET	41	52	67	64	61	63	54	46	71
	RADIATED	38	52	59	54	57	56	42	37	63
2	INLET	39	48	58	64	67	62	52	44	70
	OUTLET	38	47	61	62	60	62	51	40	68
	RADIATED	35	47	55	53	56	56	41	27	61
3	INLET	10	46	56	63	65	60	53	48	68
	OUTLET	10	46	56	62	58	59	49	39	65
	RADIATED	26	45	53	52	54	53	42	31	59
4	INLET	40	50	59	63	65	59	50	40	68
	OUTLET	38	47	63	60	56	57	49	39	66
	RADIATED	33	47	55	49	55	54	37	24	60
5	INLET	36	45	55	63	63	57	48	40	67
	OUTLET	33	42	57	60	54	55	44	33	63
	RADIATED	29	42	51	50	53	52	35	23	58
6	INLET	29	40	56	62	60	55	49	43	66
	OUTLET	27	42	52	58	51	52	42	33	61
	RADIATED	22	37	52	49	51	50	36	26	57
7	INLET	35	42	52	55	56	50	39	29	60
	OUTLET	42	50	56	54	50	49	40	29	60
	RADIATED	37	42	52	50	50	44	27	20	56
8	INLET	32	41	50	54	54	48	38	30	58
	OUTLET	42	50	53	53	48	47	35	25	58
	RADIATED	34	40	50	49	48	42	25	21	54
9	INLET	29	40	49	52	51	46	39	32	56
	OUTLET	42	50	49	50	46	45	32	25	56
	RADIATED	32	39	49	47	44	41	27	23	52
10	INLET	31	38	45	47	49	40	28	23	52
	OUTLET	30	44	48	47	44	40	28	23	52
	RADIATED	36	36	45	44	42	37	25	23	49
11	INLET	29	38	45	46	48	39	28	24	51
	OUTLET	29	45	45	46	43	39	25	23	51
	RADIATED	34	36	45	43	41	36	25	23	49
12	INLET	21	36	43	43	46	40	29	24	50
	OUTLET	28	42	43	44	42	39	25	23	49
	RADIATED	26	34	43	40	39	37	26	23	47

**PERFORMANCE CURVES - ACOUSTIC CHARACTERISTICS**

- $q_v$ : Airflow in  $m^3/h$ .
- $p_{sf}$ : Static pressure in Pa.
- P: Input power in W.
- SFP: Specific fan power in  $W/m^3/s$  (blue curves).
- Performance data in accordance with ISO 5801:1997.

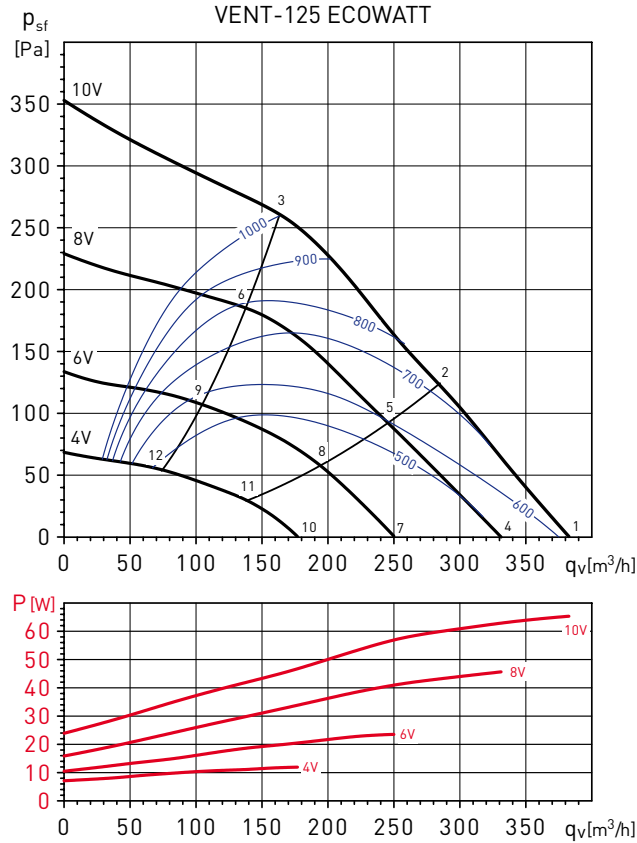

Working point		63	125	250	500	1000	2000	4000	8000	LwA
1	INLET	39	48	60	66	69	65	56	44	72
	OUTLET	43	49	66	65	63	64	56	46	71
	RADIATED	29	45	58	50	60	56	49	40	64
2	INLET	37	45	57	64	66	62	52	40	70
	OUTLET	38	45	62	63	62	60	53	42	68
	RADIATED	27	43	55	49	58	54	45	36	61
3	INLET	31	46	61	65	66	61	50	40	70
	OUTLET	35	42	58	64	61	60	52	43	67
	RADIATED	21	44	59	49	57	53	43	36	62
4	INLET	36	45	56	64	65	61	52	39	69
	OUTLET	39	46	62	62	59	58	51	41	67
	RADIATED	31	42	51	51	58	53	45	36	61
5	INLET	34	42	53	61	62	58	47	35	66
	OUTLET	34	42	58	60	57	55	47	36	64
	RADIATED	28	39	48	48	55	50	41	32	58
6	INLET	27	39	59	61	60	56	44	33	66
	OUTLET	27	38	62	59	55	54	46	39	65
	RADIATED	22	36	54	48	54	48	37	30	58
7	INLET	31	45	54	57	58	53	43	30	62
	OUTLET	42	42	56	55	52	50	42	30	60
	RADIATED	26	46	50	51	53	45	37	28	57
8	INLET	28	44	54	54	55	49	38	26	60
	OUTLET	42	41	53	53	50	47	37	26	58
	RADIATED	23	45	50	48	50	42	32	25	55
9	INLET	25	40	52	54	54	48	35	25	59
	OUTLET	42	42	53	52	49	46	36	28	57
	RADIATED	20	41	47	48	49	40	29	24	53
10	INLET	30	42	47	48	49	42	32	24	54
	OUTLET	30	41	49	47	46	41	30	23	53
	RADIATED	30	36	48	45	46	38	31	24	51
11	INLET	27	39	46	46	47	39	29	23	52
	OUTLET	29	41	47	45	45	39	27	23	51
	RADIATED	27	34	46	42	43	35	27	23	49
12	INLET	28	43	44	45	46	38	28	23	51
	OUTLET	29	41	46	44	45	38	27	23	50
	RADIATED	28	37	45	42	42	34	27	23	48

**PERFORMANCE CURVES - ACOUSTIC CHARACTERISTICS**

- $q_v$ : Airflow in  $m^3/h$ .
- $p_{sf}$ : Static pressure in Pa.
- P: Input power in W.
- SFP: Specific fan power in  $W/m^3/s$  (blue curves).
- Performance data in accordance with ISO 5801:1997.

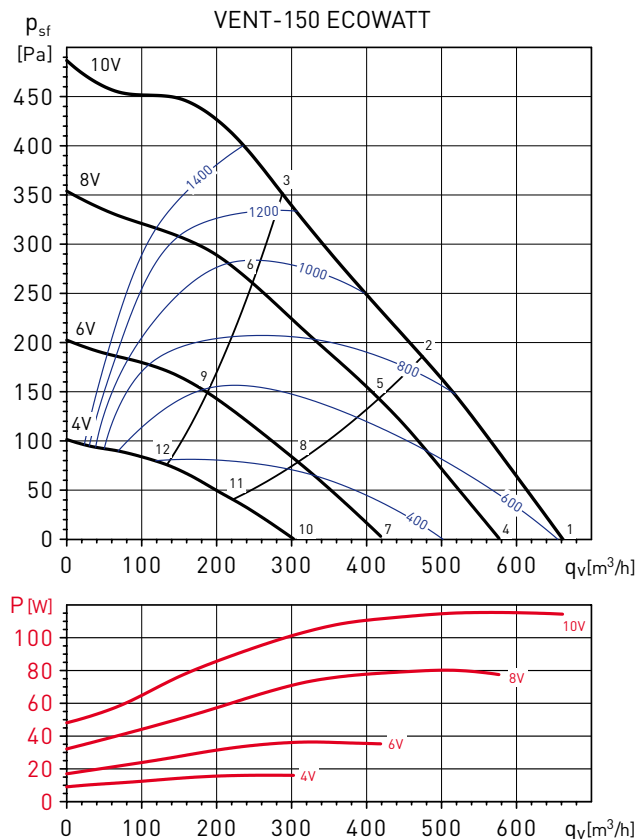

Working point		63	125	250	500	1000	2000	4000	8000	LwA
1	INLET	44	52	65	74	73	69	64	54	78
	OUTLET	44	51	68	70	71	69	64	53	76
	RADIATED	28	39	45	47	54	56	47	36	59
2	INLET	43	53	66	74	72	68	62	52	77
	OUTLET	42	53	69	69	70	67	61	51	75
	RADIATED	27	40	46	47	53	54	44	34	58
3	INLET	40	54	66	76	72	67	60	50	78
	OUTLET	39	55	69	71	70	67	60	50	76
	RADIATED	24	41	46	49	53	53	43	32	57
4	INLET	41	49	61	71	69	65	60	49	74
	OUTLET	41	49	65	67	68	65	60	48	73
	RADIATED	32	42	47	53	52	54	46	35	58
5	INLET	41	51	61	71	68	64	58	47	74
	OUTLET	40	52	66	66	67	64	58	47	72
	RADIATED	32	43	48	53	51	53	44	33	58
6	INLET	38	54	63	72	69	63	56	47	75
	OUTLET	37	57	66	67	67	64	56	46	72
	RADIATED	27	46	48	53	51	52	42	32	58
7	INLET	35	45	55	65	62	58	51	39	68
	OUTLET	34	45	58	60	60	58	51	38	65
	RADIATED	29	41	42	49	47	51	38	26	55
8	INLET	34	47	54	64	62	57	49	38	67
	OUTLET	33	49	58	59	59	56	48	37	64
	RADIATED	29	43	41	48	47	50	35	25	54
9	INLET	35	49	56	65	62	57	48	39	68
	OUTLET	33	51	57	60	59	55	47	37	65
	RADIATED	29	45	43	48	47	49	35	26	54
10	INLET	28	36	47	55	52	48	37	27	58
	OUTLET	27	38	51	51	50	46	36	26	56
	RADIATED	23	30	35	41	40	36	26	24	45
11	INLET	28	38	47	54	52	46	36	27	57
	OUTLET	28	39	49	50	50	44	34	26	55
	RADIATED	24	31	34	40	39	34	25	23	44
12	INLET	33	39	48	54	51	44	36	26	57
	OUTLET	34	40	47	49	48	42	33	26	53
	RADIATED	28	32	36	39	38	32	25	23	44

PERFORMANCE CURVES - ACOUSTIC CHARACTERISTICS

- $q_v$ : Airflow in  $m^3/h$ .
- $p_{sf}$ : Static pressure in Pa.
- P: Input power in W.
- SFP: Specific fan power in  $W/m^3/s$  (blue curves).
- Performance data in accordance with ISO 5801:1997.

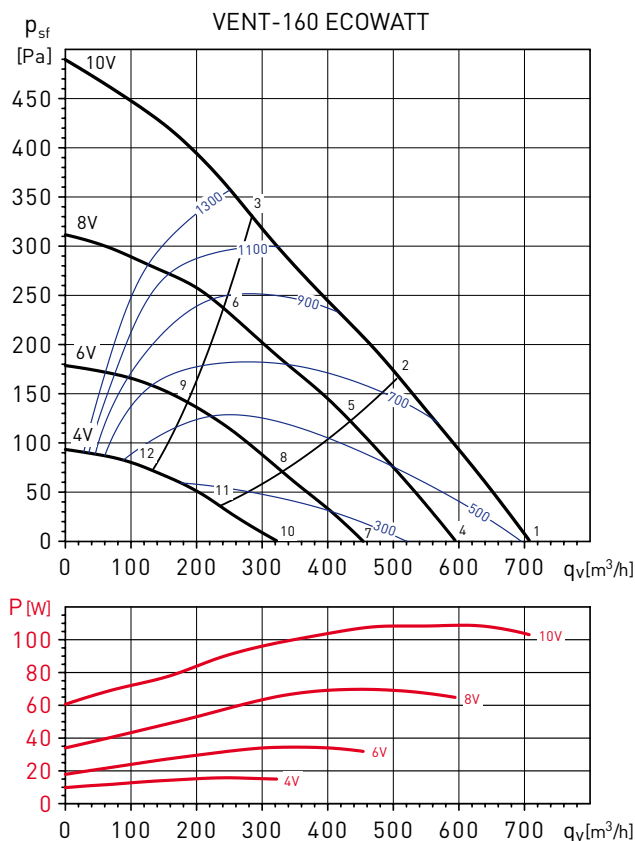

Working point		63	125	250	500	1000	2000	4000	8000	LwA
1	INLET	41	50	64	74	73	69	66	54	78
	OUTLET	41	49	67	71	71	69	65	54	76
	RADIATED	19	32	41	48	50	57	50	39	59
2	INLET	43	50	64	72	71	68	62	51	76
	OUTLET	41	50	69	69	70	68	62	51	75
	RADIATED	21	32	42	46	48	56	46	35	57
3	INLET	41	53	63	74	71	66	60	49	76
	OUTLET	40	55	67	70	69	66	60	49	74
	RADIATED	19	35	41	48	48	54	44	33	56
4	INLET	39	47	61	71	69	66	61	49	74
	OUTLET	39	46	64	67	67	66	61	49	73
	RADIATED	24	31	44	46	50	60	46	35	61
5	INLET	38	48	60	70	68	65	59	47	73
	OUTLET	38	49	64	66	66	66	58	46	72
	RADIATED	23	33	43	44	49	60	44	33	60
6	INLET	37	48	57	66	63	60	52	41	69
	OUTLET	36	50	59	62	61	61	51	41	67
	RADIATED	23	35	39	42	46	55	38	29	56
7	INLET	33	42	54	65	61	58	53	39	67
	OUTLET	32	44	56	61	60	60	52	39	65
	RADIATED	22	33	36	43	47	53	39	29	54
8	INLET	32	46	53	63	61	57	49	37	66
	OUTLET	32	49	56	59	59	59	49	37	64
	RADIATED	21	37	35	41	46	52	36	27	53
9	INLET	33	42	50	58	55	54	44	32	61
	OUTLET	33	44	52	54	53	55	42	32	60
	RADIATED	23	34	34	39	43	48	31	24	50
10	INLET	25	38	48	55	52	51	40	28	58
	OUTLET	26	37	50	51	50	52	38	27	57
	RADIATED	17	30	38	40	44	46	27	25	49
11	INLET	27	39	45	53	51	51	38	27	57
	OUTLET	28	39	48	49	49	52	36	26	56
	RADIATED	19	31	36	38	43	46	25	24	48
12	INLET	31	39	44	52	49	50	38	26	56
	OUTLET	32	38	46	47	47	51	35	26	54
	RADIATED	22	31	34	36	41	45	25	23	47

**PERFORMANCE CURVES - ACOUSTIC CHARACTERISTICS**

- $q_v$ : Airflow in  $m^3/h$ .
- $p_{sf}$ : Static pressure in Pa.
- P: Input power in W.
- SFP: Specific fan power in  $W/m^3/s$  (blue curves).
- Performance data in accordance with ISO 5801:1997.

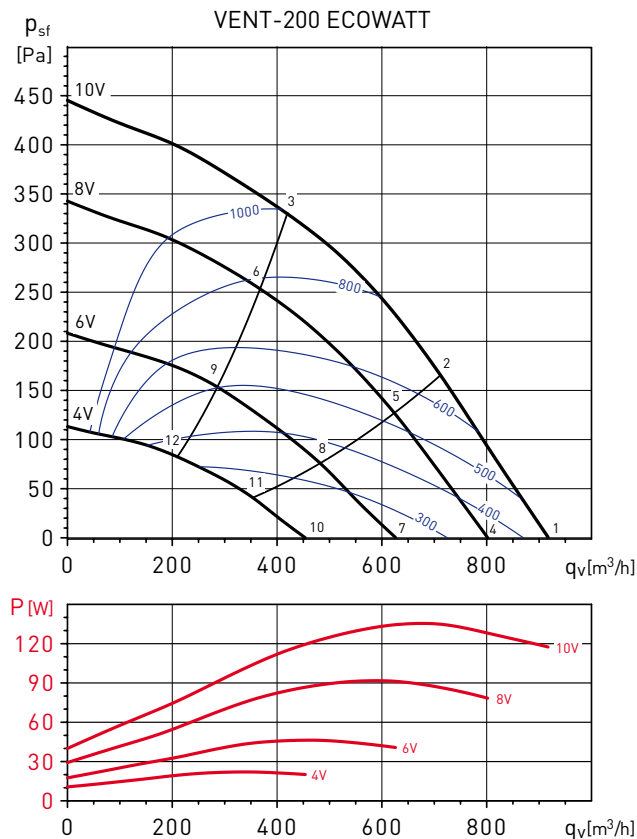

Working point		63	125	250	500	1000	2000	4000	8000	LwA
1	INLET	42	52	62	70	68	65	65	61	74
	OUTLET	41	51	66	67	68	69	66	60	75
	RADIATED	30	36	40	48	46	53	48	43	56
2	INLET	37	50	63	70	68	64	63	57	74
	OUTLET	39	51	66	67	68	68	64	56	74
	RADIATED	25	34	41	49	46	51	46	40	55
3	INLET	38	55	65	70	69	64	61	55	74
	OUTLET	38	56	69	68	69	68	63	53	75
	RADIATED	26	40	43	49	47	51	44	37	55
4	INLET	40	49	59	65	65	62	62	56	70
	OUTLET	39	48	63	64	64	66	63	55	71
	RADIATED	36	38	40	45	43	51	46	40	54
5	INLET	35	46	60	64	64	61	59	52	69
	OUTLET	36	48	63	63	64	65	61	51	70
	RADIATED	30	36	40	44	42	49	43	36	52
6	INLET	36	52	62	65	65	60	57	50	70
	OUTLET	36	53	65	64	65	64	59	49	71
	RADIATED	32	42	42	45	43	48	41	34	52
7	INLET	36	42	54	58	60	57	55	45	64
	OUTLET	35	41	57	57	59	61	57	44	65
	RADIATED	30	30	40	38	39	47	41	35	50
8	INLET	33	41	54	58	58	56	52	43	63
	OUTLET	34	42	57	57	58	59	54	42	64
	RADIATED	27	29	40	37	38	46	38	32	48
9	INLET	35	47	55	58	59	54	49	41	63
	OUTLET	35	47	59	57	59	58	52	40	65
	RADIATED	29	34	42	38	38	45	35	30	48
10	INLET	29	35	46	53	53	52	44	34	58
	OUTLET	29	34	48	50	51	54	45	32	58
	RADIATED	25	27	35	35	39	44	35	32	46
11	INLET	30	35	46	52	52	50	41	32	56
	OUTLET	31	35	49	49	50	51	42	30	56
	RADIATED	26	27	35	34	37	41	32	30	44
12	INLET	37	37	47	51	51	46	39	29	56
	OUTLET	36	36	51	49	50	49	41	28	56
	RADIATED	33	29	36	33	37	37	30	27	43



PERFORMANCE CURVES - ACOUSTIC CHARACTERISTICS

- $q_v$ : Airflow in  $m^3/h$ .
- $p_{sf}$ : Static pressure in Pa.
- P: Input power in W.
- SFP: Specific fan power in  $W/m^3/s$  (blue curves).
- Performance data in accordance with ISO 5801:1997.

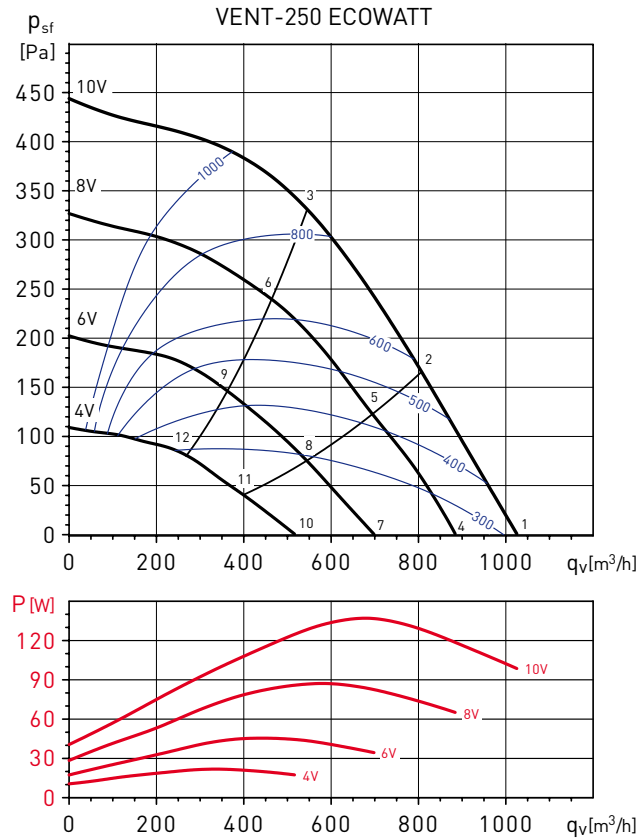

Working point		63	125	250	500	1000	2000	4000	8000	LwA
1	INLET	39	52	63	73	73	70	68	62	78
	OUTLET	40	52	65	73	73	74	70	63	79
	RADIATED	30	45	43	55	54	55	54	46	61
2	INLET	36	52	61	71	71	68	67	59	76
	OUTLET	38	52	64	71	71	72	68	60	77
	RADIATED	28	45	41	53	52	53	52	43	59
3	INLET	38	54	64	68	68	64	63	55	73
	OUTLET	39	57	66	70	69	69	64	56	75
	RADIATED	30	47	44	51	49	49	48	39	56
4	INLET	37	50	60	69	70	66	64	57	74
	OUTLET	38	51	62	73	70	70	66	58	76
	RADIATED	26	43	40	52	50	52	50	42	57
5	INLET	34	49	58	67	68	64	62	53	72
	OUTLET	36	51	61	70	68	68	64	54	74
	RADIATED	23	42	39	50	48	50	48	38	55
6	INLET	37	51	60	64	65	61	58	50	69
	OUTLET	38	54	63	67	65	65	60	50	72
	RADIATED	26	45	41	47	45	47	43	34	53
7	INLET	33	45	56	61	63	60	58	46	67
	OUTLET	35	44	62	69	64	64	60	47	72
	RADIATED	27	36	39	44	44	45	44	35	51
8	INLET	31	43	54	59	61	58	54	44	65
	OUTLET	33	43	58	66	62	63	57	45	69
	RADIATED	25	34	37	42	42	44	40	33	49
9	INLET	38	44	55	57	58	55	50	40	63
	OUTLET	38	44	57	62	60	60	52	41	66
	RADIATED	32	35	38	40	38	41	36	30	46
10	INLET	30	37	50	56	56	53	46	34	61
	OUTLET	35	44	62	69	64	64	60	47	72
	RADIATED	22	29	37	39	37	40	37	32	46
11	INLET	35	38	48	54	55	51	43	32	59
	OUTLET	33	43	58	66	62	63	57	45	69
	RADIATED	27	30	35	38	36	39	33	30	44
12	INLET	35	38	47	51	52	48	39	29	56
	OUTLET	38	44	57	62	60	60	52	41	66
	RADIATED	27	29	34	34	33	35	30	27	41

PERFORMANCE CURVES - ACOUSTIC CHARACTERISTICS

- $q_v$ : Airflow in  $m^3/h$ .
- $p_{sf}$ : Static pressure in Pa.
- P: Input power in W.
- SFP: Specific fan power in  $W/m^3/s$  (blue curves).
- Performance data in accordance with ISO 5801:1997.

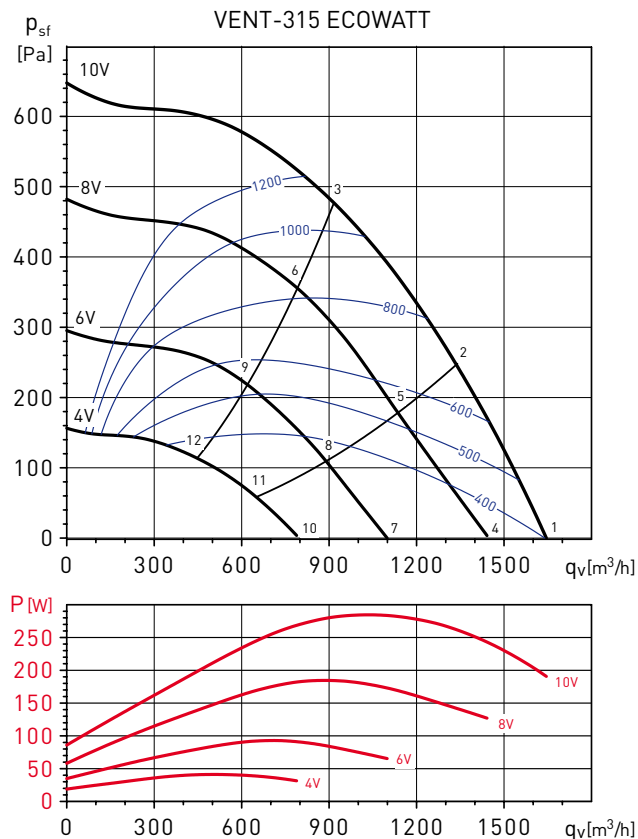

Working point		63	125	250	500	1000	2000	4000	8000	LwA
1	INLET	42	59	71	76	79	77	72	71	83
	OUTLET	43	55	76	77	79	79	74	70	84
	RADIATED	24	35	44	54	66	62	55	51	68
2	INLET	41	59	70	75	76	74	70	68	81
	OUTLET	41	55	74	75	77	78	72	68	83
	RADIATED	22	35	42	53	63	60	53	48	66
3	INLET	42	58	69	73	73	73	67	62	79
	OUTLET	43	55	74	76	76	74	69	65	82
	RADIATED	23	35	42	51	60	58	50	42	63
4	INLET	43	56	68	72	75	72	68	67	79
	OUTLET	41	53	73	72	75	75	70	67	81
	RADIATED	27	34	41	52	62	63	52	49	66
5	INLET	40	56	66	70	73	71	66	64	77
	OUTLET	40	52	70	71	74	74	68	64	79
	RADIATED	24	34	39	50	60	61	50	45	64
6	INLET	41	57	67	70	71	68	64	58	76
	OUTLET	41	52	70	72	72	71	65	60	78
	RADIATED	25	35	40	51	58	58	48	40	62
7	INLET	38	52	62	69	68	64	63	54	73
	OUTLET	38	48	69	67	68	68	64	55	75
	RADIATED	27	31	41	63	59	60	48	41	66
8	INLET	39	50	60	68	66	63	61	49	71
	OUTLET	39	47	66	67	66	67	61	51	73
	RADIATED	28	29	39	62	57	58	45	36	65
9	INLET	36	51	61	67	64	60	56	47	70
	OUTLET	36	48	67	66	64	64	57	49	72
	RADIATED	25	30	40	61	55	56	41	34	63
10	INLET	33	46	54	61	61	58	59	42	66
	OUTLET	38	48	69	67	68	68	64	55	75
	RADIATED	25	32	40	58	50	52	48	38	60
11	INLET	34	43	53	59	60	56	54	39	64
	OUTLET	39	47	66	67	66	67	61	51	73
	RADIATED	26	30	39	56	49	50	43	35	58
12	INLET	34	44	55	58	58	54	47	37	63
	OUTLET	36	48	67	66	64	64	57	49	72
	RADIATED	26	30	41	55	47	48	35	33	56

PERFORMANCE CURVES - ACOUSTIC CHARACTERISTICS

- $q_v$ : Airflow in  $m^3/h$ .
- $p_{sf}$ : Static pressure in Pa.
- P: Input power in W.
- SFP: Specific fan power in  $W/m^3/s$  (blue curves).
- Performance data in accordance with ISO 5801:1997.

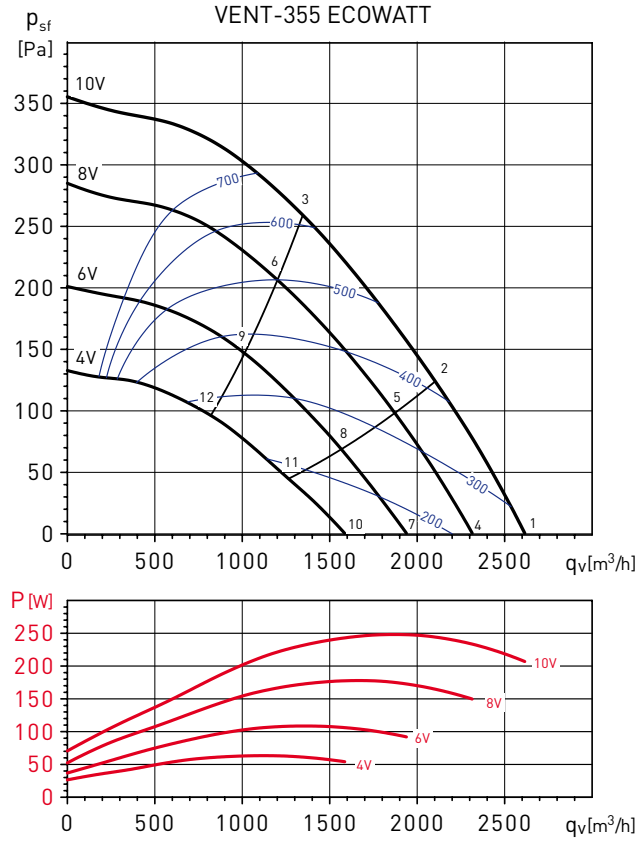

Working point		63	125	250	500	1000	2000	4000	8000	LwA
1	INLET	40	58	68	72	68	66	61	52	75
	OUTLET	42	61	70	72	74	69	61	53	78
	RADIATED	29	42	55	57	63	57	48	41	66
2	INLET	38	56	65	70	66	63	57	49	73
	OUTLET	40	59	68	70	72	66	57	50	75
	RADIATED	27	41	52	55	61	54	45	38	63
3	INLET	40	58	60	65	61	59	53	46	69
	OUTLET	40	58	60	65	61	59	53	46	69
	RADIATED	29	42	47	50	57	50	41	36	59
4	INLET	38	60	64	69	66	63	56	48	72
	OUTLET	39	64	63	69	71	66	57	49	75
	RADIATED	28	47	47	55	60	56	44	40	62
5	INLET	36	57	61	67	63	59	53	44	70
	OUTLET	37	61	60	66	68	62	53	45	72
	RADIATED	25	44	44	52	57	53	41	36	59
6	INLET	38	56	57	62	58	55	49	41	65
	OUTLET	37	59	57	62	64	59	50	42	68
	RADIATED	27	43	40	47	52	48	37	34	55
7	INLET	35	59	61	67	61	59	51	42	69
	OUTLET	36	63	59	66	66	61	51	42	71
	RADIATED	31	41	46	54	55	52	41	38	59
8	INLET	33	56	59	64	58	56	48	39	67
	OUTLET	34	58	56	64	63	58	47	39	68
	RADIATED	29	38	44	51	52	49	38	35	56
9	INLET	34	53	54	58	53	52	44	36	62
	OUTLET	33	55	53	59	59	54	44	36	64
	RADIATED	29	35	39	45	47	45	34	32	51
10	INLET	32	48	60	62	56	52	44	35	65
	OUTLET	32	49	59	62	60	55	43	36	66
	RADIATED	27	40	45	48	53	45	39	34	55
11	INLET	30	47	58	60	52	49	40	33	63
	OUTLET	32	47	57	59	57	51	40	33	63
	RADIATED	24	38	44	45	50	42	35	32	52
12	INLET	30	46	53	56	49	45	37	31	59
	OUTLET	31	48	52	56	55	48	37	31	60
	RADIATED	24	37	39	42	46	38	32	30	49

**PERFORMANCE CURVES - ACOUSTIC CHARACTERISTICS**

- $q_v$ : Airflow in  $m^3/h$ .
- $p_{sf}$ : Static pressure in Pa.
- P: Input power in W.
- SFP: Specific fan power in  $W/m^3/s$  (blue curves).
- Performance data in accordance with ISO 5801:1997.

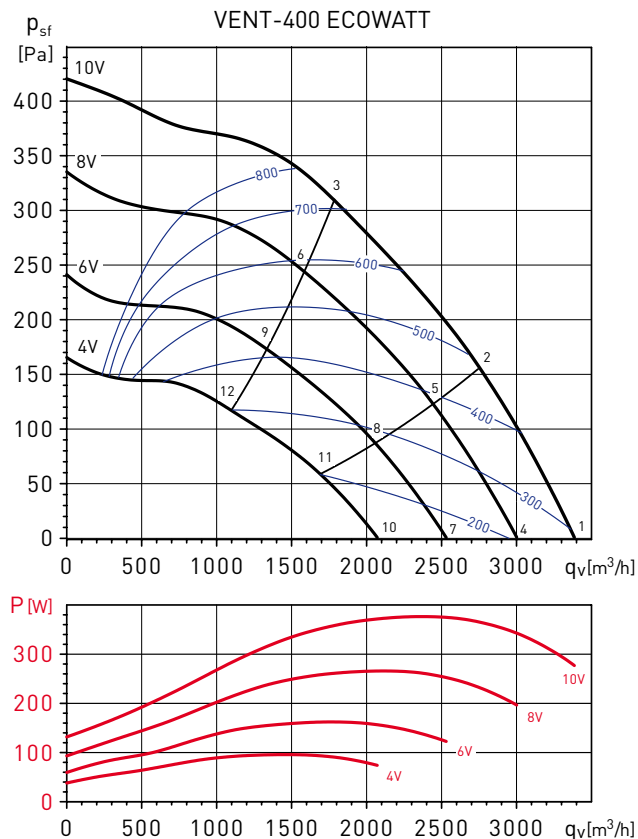

Working point		63	125	250	500	1000	2000	4000	8000	LwA
1	INLET	45	65	69	73	67	69	65	52	77
	OUTLET	46	73	68	74	72	70	65	54	79
	RADIATED	39	55	57	59	61	57	49	37	65
2	INLET	43	66	68	72	66	65	59	50	75
	OUTLET	44	73	67	73	71	67	59	51	78
	RADIATED	37	56	56	58	59	54	44	35	64
3	INLET	46	65	64	68	64	60	56	50	72
	OUTLET	44	70	65	71	70	65	57	50	76
	RADIATED	40	55	52	55	57	49	41	34	61
4	INLET	42	60	69	69	64	66	58	48	74
	OUTLET	43	66	67	71	69	66	58	49	75
	RADIATED	35	55	57	57	59	55	42	33	64
5	INLET	40	59	67	69	62	60	53	45	72
	OUTLET	41	65	66	71	67	62	54	46	74
	RADIATED	33	54	55	56	57	49	38	30	62
6	INLET	44	60	62	67	61	57	52	45	70
	OUTLET	41	63	64	69	67	61	53	44	73
	RADIATED	37	54	51	54	56	46	37	31	60
7	INLET	39	55	64	64	61	62	51	43	69
	OUTLET	40	57	65	66	65	63	52	45	71
	RADIATED	32	48	53	51	55	51	35	30	59
8	INLET	37	55	62	62	59	56	47	39	67
	OUTLET	38	56	63	64	64	58	48	41	69
	RADIATED	30	47	52	49	53	44	32	27	57
9	INLET	40	55	58	60	56	53	47	40	64
	OUTLET	41	57	60	63	63	57	47	39	68
	RADIATED	34	48	47	47	50	41	32	27	55
10	INLET	39	52	57	58	58	54	43	36	64
	OUTLET	42	54	57	60	61	56	44	37	65
	RADIATED	39	46	47	46	53	42	31	29	55
11	INLET	40	51	56	56	55	49	40	33	61
	OUTLET	41	53	55	58	58	51	41	34	63
	RADIATED	39	45	46	44	49	37	28	26	53
12	INLET	38	50	53	55	53	47	40	34	59
	OUTLET	40	53	54	57	57	50	40	33	62
	RADIATED	37	45	43	43	47	35	28	26	51

**MOUNTING ACCESSORIES**

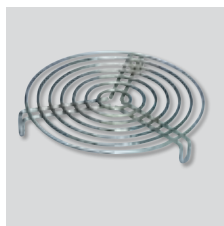

**DEF-VENT**  
Protection grille.



**ACOP-VENT**  
Flexible connectors.



**MFL-G4**  
G4 filtration box.



**MBE**  
Electric heaters.

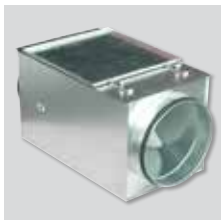

**MFL-F**  
Filtration box for  
MFR bag filters F5,  
F6 or F7 grade.



**SIL**  
Circular sound  
attenuators.



**CAR**  
Backdraught  
shutters.

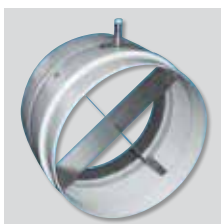

**MPC**  
Flow detectors.

**ELECTRICAL ACCESSORIES**



**CONTROL ECOWATT  
AC/4A**  
Control element for  
demand controlled  
ventilation systems.



**REB-ECOWATT**  
Speed controller for  
fans fitted with EC  
motor.



**SC02-A**  
CO<sub>2</sub> and temperature  
sensor.  
**SC02-AD**  
CO<sub>2</sub> and temperature  
sensor, with display.  
**SCHT-AD**  
CO<sub>2</sub>, temperature  
and relative humidity  
sensor with display.



**CPFL-S / CPFL-E**  
Presence detector.



**TDP-S / TDP-D**  
Pressure sensor.

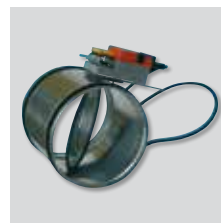

**REMP**  
Motorised damper.